

• **TRAVERSE • WHEEL-FREE JACKS • ACHSHEBER**  
 • **TRAVERSES DE LEVAGE • GATOS DE ELEVACIÓN**



Fare riferimento al listino prezzi per i codici dei ponti dove utilizzare ogni traversa.  
 See pricelist for lifts applicability of each wheel free jack.  
 Siehe Preisliste für den genauen Einsatz auf Hebebühnentyp.  
 Voir le tarif pour les références des élévateurs ou utiliser chaque traverse.  
 Ver la lista de precios para las referencias de los elevadores donde utilizar cada gato.

- Grande corsa di sollevamento
- Dispositivo di traslazione su rulli elastici
- Dispositivo di arresto meccanico ad inserimento automatico e sblocco manuale
- Comando di discesa a due mani, a uomo presente
- *Great lifting height*
- *Translation device on elastic rollers*
- *Automatically-engaging and pneumatic-release mechanical lock device*
- *Two-hand "deadman" lowering control*
- Grosser Hublauf
- Translationsvorrichtung auf Federrollen
- Mechanische Stützeinrichtung mit automatischer Einrastung und pneumatischer Entriegelung
- Zweihand-Absenksteuerung mit Totmannsystem
- *Grande course de levage.*
- *Dispositif de translation sur rouleaux élastiques.*
- *Dispositif d'arrêt mécanique à introduction automatique et dégagement manuel.*
- *Commande de descente à deux mains de type "homme mort".*
- Grande altura de elevación.
- Dispositivo de traslación sobre rodillos elásticos.
- Dispositivo de bloqueo mecánico a inserción automática y desbloqueo manual.
- Mando de bajada a dos manos de tipo hombre presente.



J20 PNX



**J20 Series - 2.000 kg**

manual <b>M</b>	air hydraulic (6-10 bar) <b>P</b>	air-hydraulic large (6-10 bar) <b>P</b>	
J20NX	J20PNX	J20PNXL	<p>Not 8 ton      Open Front</p> <p>600 Series (not for 600N Series)      Extra low</p>
	J20PNR	J20PNRL	<p>600 Series (not for 600N Series)</p> <p>Vedi listino/See price list</p>
	J520PR	J520PRL	<p>600N Series</p>

**M**

Traversa idraulica con pompa a mano  
 Hydraulic wheel-free jack with hand-pump  
 Hydraulischer Achsheber mit Handpumpe  
 Traverse hydraulique avec pompe manuelle  
 Gato hidráulico con bomba de mano

**P**

Traversa pneumoidraulica  
 Air-hydraulic wheel-free jack  
 Lufthydraulischer Achsheber  
 Traverse hydro-pneumatique  
 Gato neumohidráulico

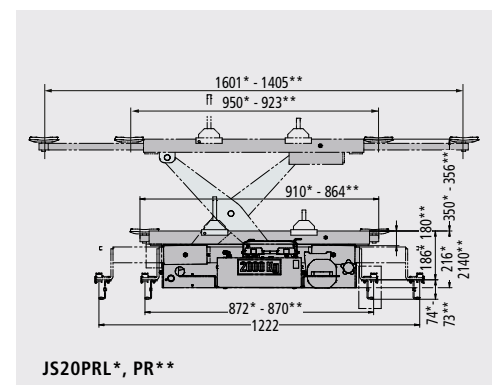
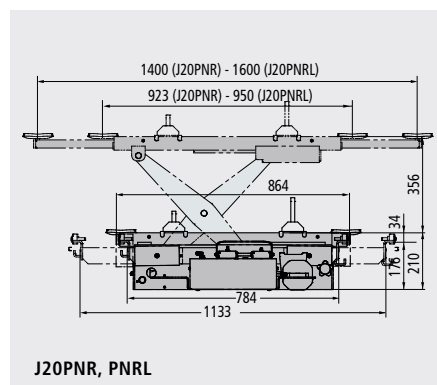
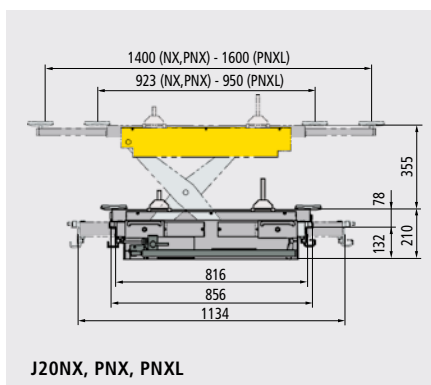



J17X

### JS17 - J17X - 2.000 kg

- Azionamento tramite pompa a mano.
- Dispositivo di arresto meccanico ad inserimento automatico e sblocco manuale
- Comando di discesa a due mani, a uomo presente
- Operated by means of hand-pump
- Automatically-engaging and hand-released mechanical lock device
- Two-hand "deadman" lowering control
- Antrieb über Handpumpe
- Mechanische Stützvorrichtung mit automatischer Einrastung und pneumatischer Entriegelung
- Zweihand-Absenkesteuerung mit Totmannsystem
- Actionnement au moyen d'une pompe manuelle
- Dispositif d'arrêt mécanique à introduction automatique et dégagement manuel.
- Commande de descente à deux mains de type "homme mort".
- Accionamiento a través de bomba de mano
- Dispositivo de bloqueo mecánico a inserción automática y desbloqueo manual.
- Mando de bajada a dos manos de tipo hombre presente.

manual large

M

J17X

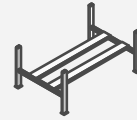

Not 8 ton



600 Series  
(not for 600N Series)



Extra low

JS17



600N Series

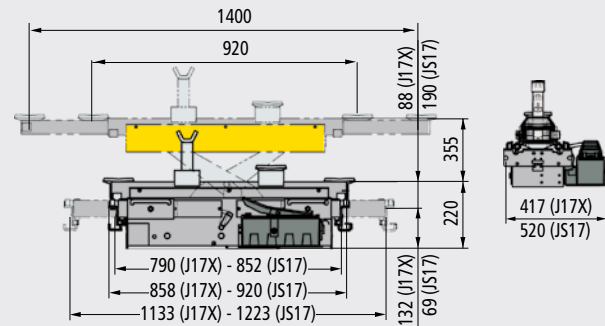

### KP111X - 1000 kg

Traversa pneumatica.  
Pressione massima 5 bar.  
Pneumatic wheel-free jack.  
Max pressure 5 bar.  
Pneumatischer Achsheber.  
Max. Druck 5 bar.  
Traverse pneumatique.  
Pression maxi 5 bars.  
Gato neumático.  
Presión máxima 5 bares.

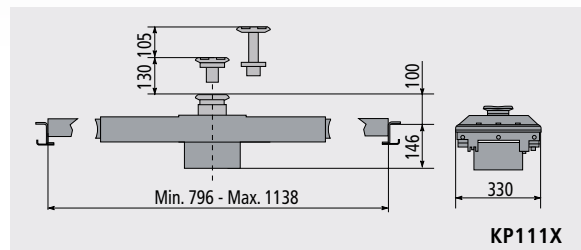
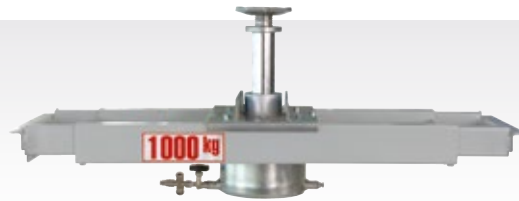

KP111X

air hydraulic (5 bar)

P



KP111X

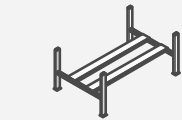

Not 8 ton



600 Series  
(not for 600N Series)

### J50 SERIES - 5.000 kg

- Grande corsa di sollevamento
- Great lifting height
- Grosser Hublauf
- Grande course de levage
- Grande altura de elevación



J50 PHA

air-hydraulic  
(6-10 bar)

P



J50PHA

4 colonne elettroidraulici / Electro-hydraulic 4-post lifts /  
Elektrohydraulische 4-Säulen Hebebühnen / 4 colonnes  
électro-hydrauliques / 4 columnas electrohidráulicos  
→ 6,5 ton + S4651LA1  
→ 8 ton + S4800A4

J50PHT

→ Sollevatori a forbice per camion / Truck scissor  
lifts / Scherenbehebühnen für LKW / Élévateurs a  
ciseaux pour véhicules industriels / Elevadores da  
tijera para vehiculos industriales

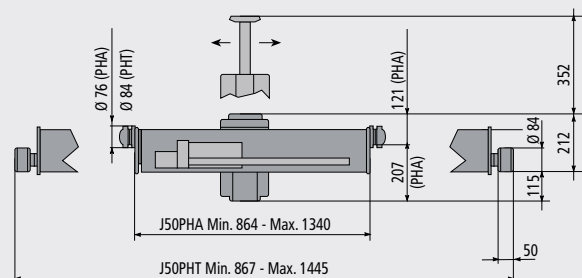







J30PXL







J40 PXL

**J30 Series - 3.000 kg**

manual	air hydraulic (6-10 bar)	air-hydraulic large (6-10 bar)	
M	P	P	
J30X	J30PX	J30PXL	 <p>≥ 4 Ton - not 8 ton</p>
J30R Ribassata / Extra low / Extra niedrig Extra plat / Extra baja	J30PR	J30PRL	 <p>≥ 4 Ton (600 Series) Open Front</p>
	JS30PR	JS30PRL	 <p>600N Series</p>
	J30PK	J30PKL	 <p>8 Ton + S4800A4</p>

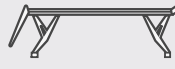
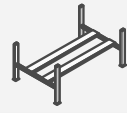
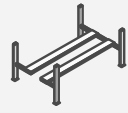

**J40 Series - 4.000 kg P**  
air-hydraulic large (6-10 bar)

J40PY	→		
J40PXL	→	 <p>6,5 Ton</p>  <p>Open Front</p>	
J40 PRL Ribassata Extra low Extra niedrig Extra plat Extra baja	→	<p>≥ 6 Ton</p> <p>600 Series (not for 600N Series)</p> 	
JS40PRL	→	<p>≥ 6 Ton</p> <p>600N Series</p> 	
J40 PXL	→	<p>8 ton + S4800A4</p> 	

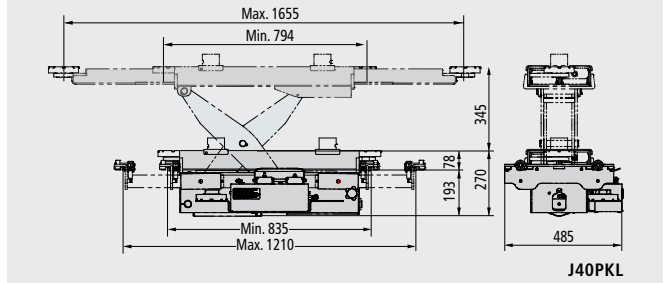
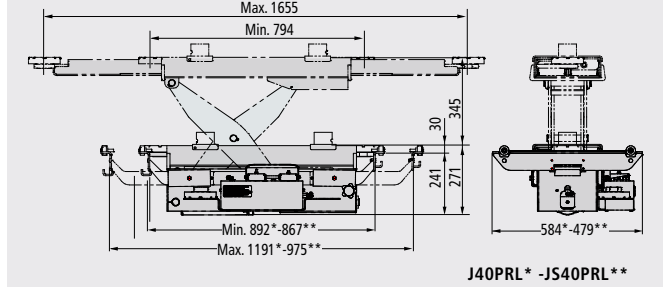
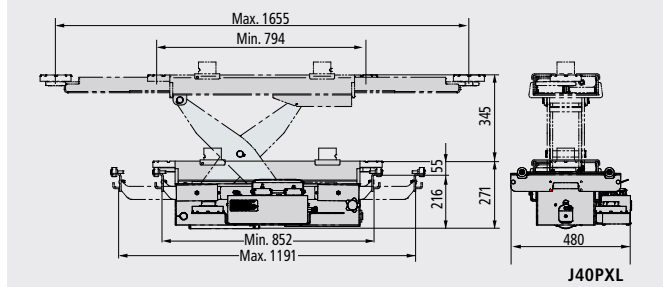
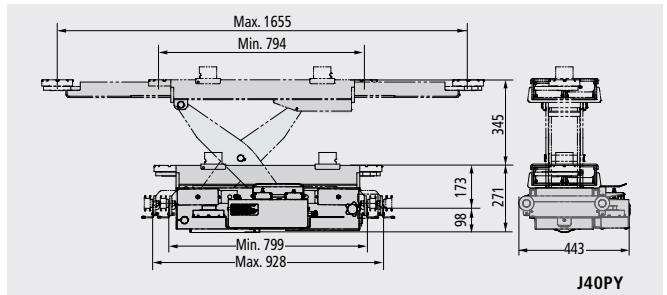
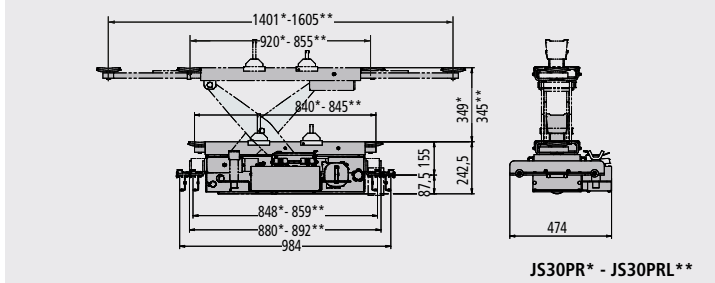
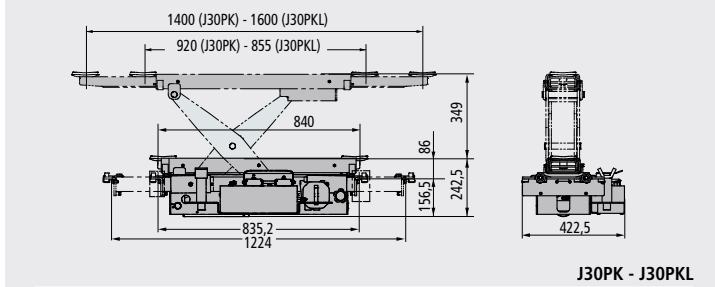
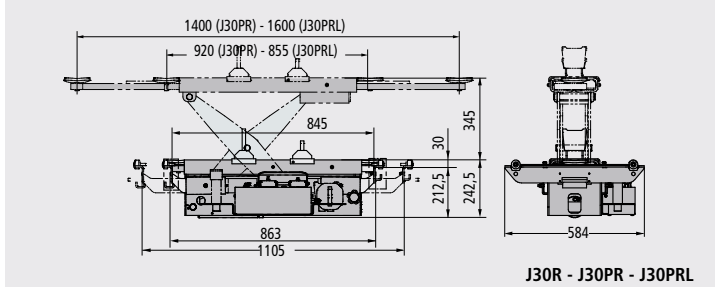
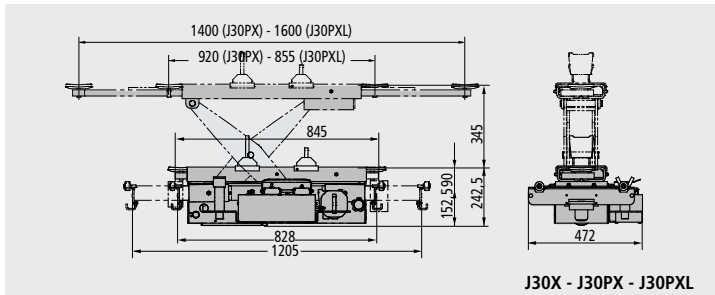

**KP118NP - 13.500 kg**

**KP118/440P - 13.500 kg**

Idropneumatica - Air-hydraulic - Lufthydraulisch  
Hydro-pneumatique - Neumohidráulico



KP118/440P e KP118NP

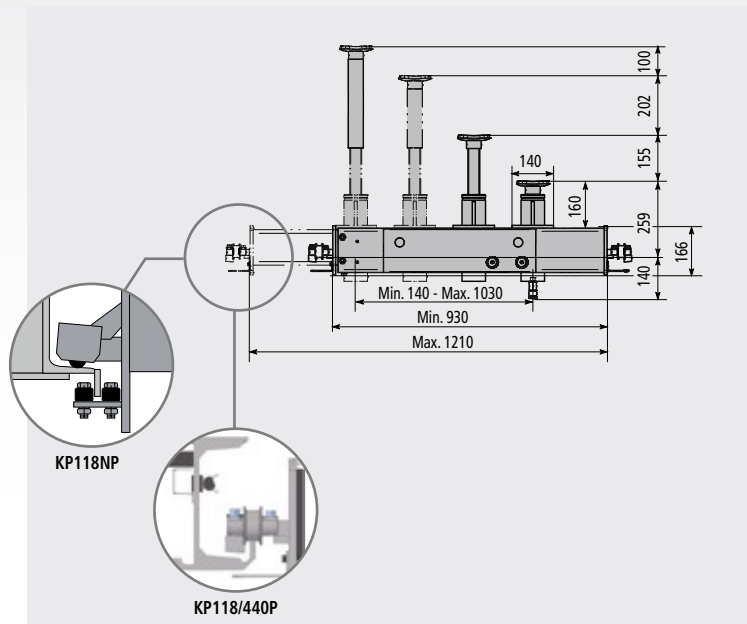

air-hydraulic  
(6-10 bar)

**P**



→ Sollevatori elettromeccanici a 4 colonne / Electro-mechanical 4 post lifts / Elektromechanische 4-Säulen-Hebebühnen / Elevateurs electromecaniques 4 colonnes / Elevadores electromecánicos de 4 columnas

**KP118 NP** (→ 12 ton, 14 ton)

**KP118/440P** (→ 24 ton)

**KP118 - 13.500 kg**

Pompa a mano - Hand pump - Handpumpe  
Pompe manuelle - Bomba de mano

**KP118 P - 13.500 kg**

Idropneumatica - Air-hydraulic - Lufthydraulisch  
Hydro-pneumatique - Neumohidráulico

	air-hydraulic (6-10 bar)	
manual	<b>P</b>	
<b>M</b>	<b>P</b>	
<b>KP118</b>	<b>KP118 P</b>	fossa - pit - Grube - fosse - foso

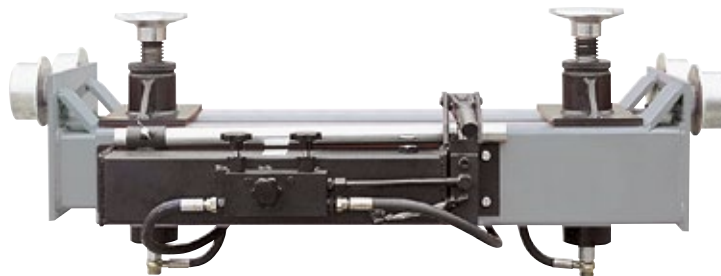

KP 118

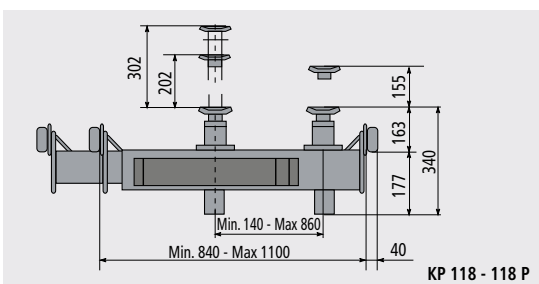

KP 118 - 118 P



KP 118 P

**STANDARD: KP118, KP118P, KP118NP**

